

ACCORDION FOLDING GRILLES

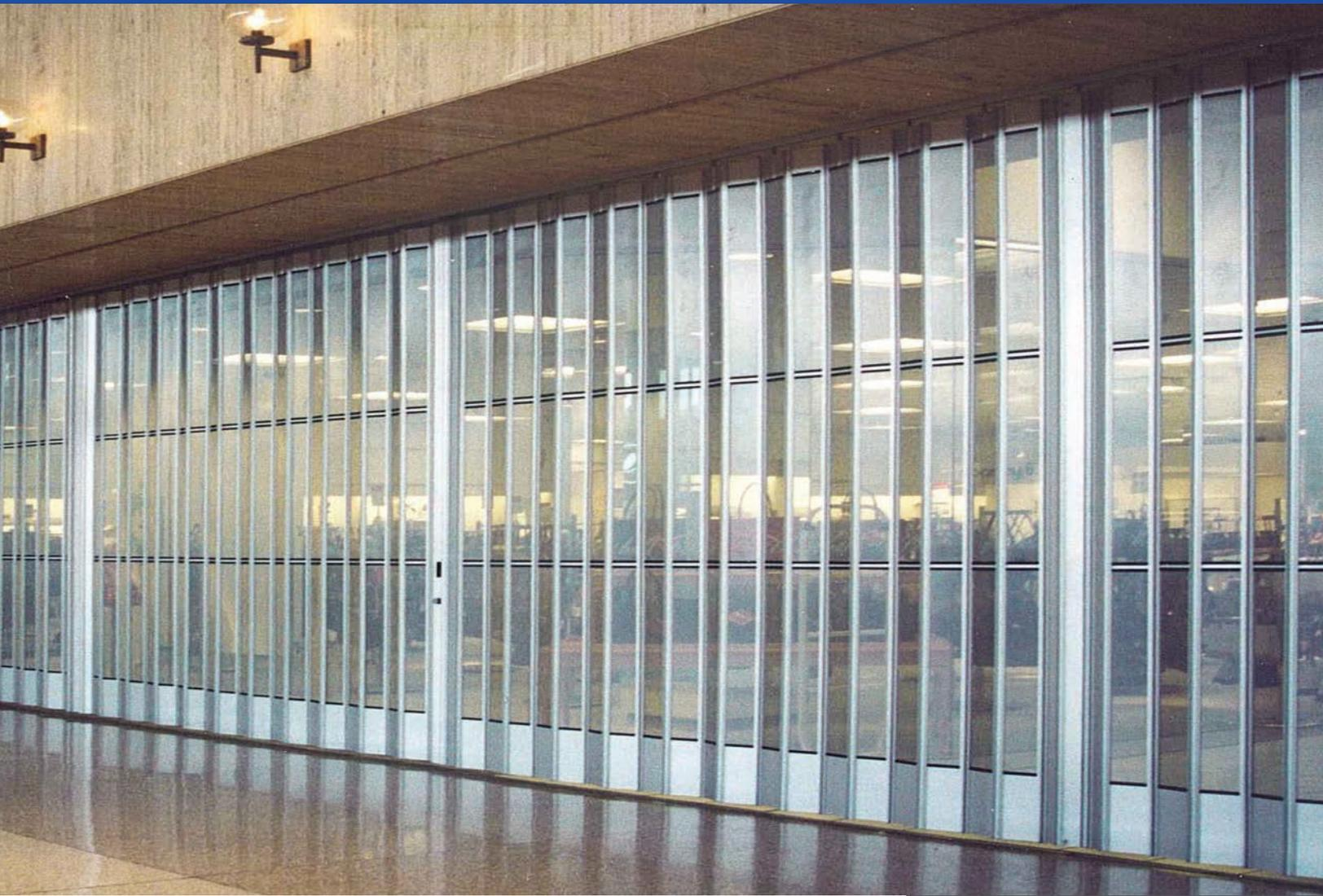

SECURE FULL-CLOSURE DESIGNS

Accordion Folding Grilles feature side-folding closures with a variety of options and patterns to fit your project needs. These side-folding grilles are ideal for retail applications in malls, airports and concourses.

- » ALUMINUM CONSTRUCTION
- » DURABLE, CLEAR ANODIZED FINISH ON EXPOSED ALUMINUM SURFACES
- » WIDE VARIETY OF PATTERNS
- » FULL-HEIGHT ALUMINUM FOR MAXIMUM SECURITY

ACCORDION FOLDING GRILLES

Features And Options

Pocket – Includes the storage pocket complete with an aluminum pocket door and adjustable height, installation is a breeze. Available in a wide variety of sizes.

Finish – Durable, clear anodized finish on exposed aluminum surfaces. Optional colors available

Posts – Many ways to secure the curtain with a wide variety of locking posts.

Track – The durable hardened track allows for smooth operation. Optional curves and custom curves available.

Egress – Emergency egress fire exit is available to meet fire code regulations.

Cylinders – Locking posts supplied with 1" mortise cylinder can be easily changed onsite. Optional SFIC housing and cores available.

Technical Details

It is important that the entire header-support handle the stacked weight.

LOAD REQUIREMENTS (LBS/SQFT)

MODEL	STACKED	EXTENDED
EZ Grille	6.5	0.75
EZ Vent	9	1.10
EZ Guard	10	1.30

MAXIMUM HEIGHTS

MODEL	MAX HEIGHT	MAX WIDTH
EZ Grille	12'0"	Unlimited
EZ Vent	12'0"	Unlimited
EZ Guard	12'0"	Unlimited

POCKET DIMENSIONS

POCKET DEPTH	EZ VENT/GUARD CLEAR OPENING CURTAIN WIDTH	EZ GRILLE CLEAR OPENING CURTAIN WIDTH
11"	Up to 64" (5' 4")	Up to 60" (5' 0")
15-1/2"	Up to 110" (9' 2")	Up to 102" (8' 4")
20"	Up to 125" (10' 5")	Up to 120" (10' 0")
25"	Up to 175" (14' 7")	Up to 162" (13' 6")
31"	Up to 234" (19' 6")	Up to 218" (18' 2")
36"	Up to 249" (20' 9")	Up to 240" (20' 9")
39"	Up to 282" (23' 6")	Up to 268" (22' 4")
42"	Up to 309" (25' 9")	Up to 292" (24' 4")
48"	Up to 360" (30' 0")	Up to 348" (29' 0")
51"	Up to 360" (30' 0")	Up to 348" (29' 0")
54"	Up to 381" (31' 9")	Up to 362" (30' 2")
58"	Up to 420" (35' 0")	Up to 402" (33' 6")
60"	Up to 440" (36' 8")	Up to 419" (34' 10")
64"	Up to 478" (39' 10")	Up to 458" (38' 2")
68"	Up to 488" (40' 8")	Up to 468" (39' 0")
72"	Up to 526" (43' 10")	Up to 506" (42' 2")

Grille Styles

STANDARD RODS

1 7/8" STRAIGHT (SWBS)

A	Space between tubes 1 7/8 in.
B	Full panel width 11 1/4 in.
C	Top plate 5 1/4 in. 11 ga.
D	Top spacer tube size varies from curtain pattern to accommodate specific height.
E	Spacer plate 1 in. 11 ga.
F	Spacer tube 1/2 in x 12 in.
G	Bottom plate 4 in. 11 ga.
H	On center 10 1/2 in.
I	Hinge 1 1/2 in.

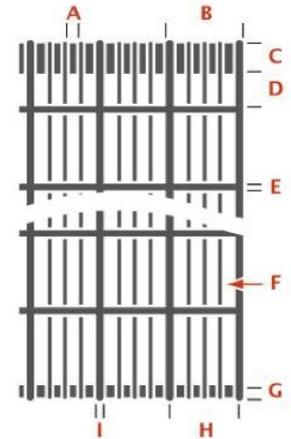

2 1/2" STRAIGHT (S126S)

A	Space between tubes 2 1/2 in.
B	Full panel width 6 5/16 in.
C	Top plate 5 1/4 in. 13 ga.
D	Top spacer tube size varies from curtain pattern to accommodate specific height.
E	Aluminum rod 5/16 in.
F	Aluminum link 1/8 in. X 5/8 in. X 6 11/16 in.
G	Spacer tube 1/2 in. X 12 in.
H	Bottom plate 5 1/4 in. 13 ga.
I	6 in. on center

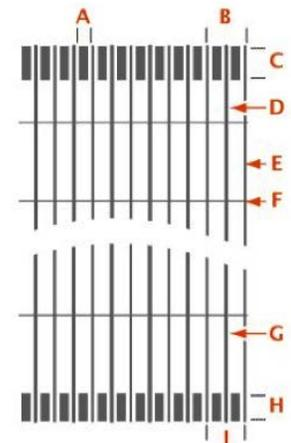

3 1/8" STRAIGHT (SL154)

A	Space between hinges - 3 1/8 in.
B	Full panel width - 4 3/16 in.
C	Top plate 2 in. 13 ga. aluminum
D	Top spacer tube size varies to accommodate specific height
E	Aluminum rod 5/16 in. covered with 1/2 in. X 15 in. aluminum tubes
F	Link 1/8 in. X 5/8 in. aluminum
G	Bottom plate 2 in. 13 ga. aluminum
H	Rods 3 1/2 in. on center

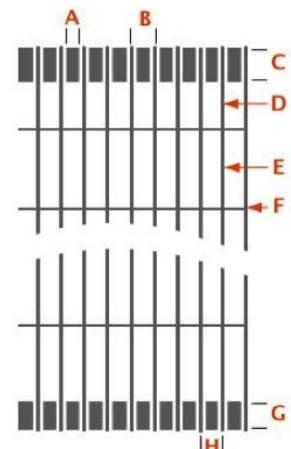

COMMERCIAL DOORS



1 7/8" BRICK (SWBB)	
A	Space between tubes 1 7/8 in.
B	Full panel width 11 1/4 in.
C	Top plate 5 1/4 in. 11 ga.
D	Top spacer tube size varies from curtain pattern to accommodate specific height.
E	Spacer plate 1 in. 11 ga.
F	Spacer tube 1/2 in x 12 in.
G	Bottom plate 4 in. 11 ga.
H	On center 10 1/2 in.
I	Hinge 1 1/2 in.

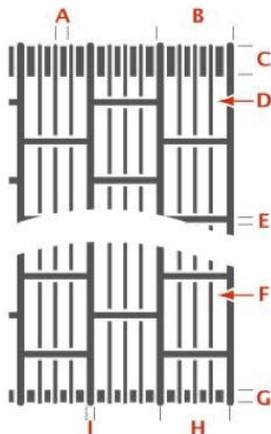

2 1/2" BRICK (S126B)	
A	Space between tubes 2 1/2 in.
B	Full panel width 6 5/16 in.
C	Top plate 5 1/4 in. 13 ga.
D	Top spacer tube size varies from curtain pattern to accommodate specific height.
E	Aluminum rod 5/16 in.
F	Aluminum link 1/8 in. X 5/8 in. X 6 11/16 in.
G	Spacer tube 1/2 in. X 12 in.
H	Bottom plate 5 1/4 in. 13 ga.
I	6 in. on center

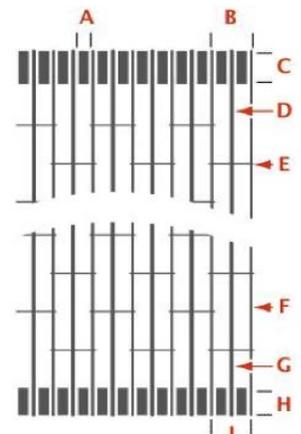

ACCORDION FOLDING GRILLES

Grille Styles

STANDARD CLOSURES

4 3/4" GLASS (FUTURA)

A	Tempered glass 4 3/4 in. X 1/8 in.
B	Full panel width 7 in.
C	Top plate 5 1/4 in. 13 ga.
D	Top spacer tube size varies from curtain pattern to accommodate specific height.
E	Spacer plate with vinyl compression gasket 1 1/4 in. 13 ga.
F	Bottom plate 4 in. 13 ga.
G	On center 6 1/4 in.
H	Hinge 1 1/2 in.

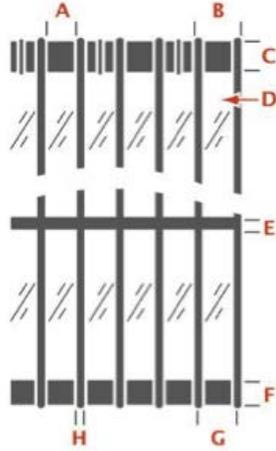

8 7/8" GLASS (FUTURA WB)

A	Tempered glass 8 7/8 in. X 1/8 in.
B	Full panel width 11 1/4 in.
C	Top plate 5 1/4 in. 11 ga.
D	Top spacer panel size varies from curtain pattern to accommodate specific height.
E	Spacer plate with vinyl compression gasket 1 1/4 in. 11 ga.
F	Bottom plate 4 in. 11 ga.
G	On center 10 1/2 in.
H	Hinge 1 1/2 in.

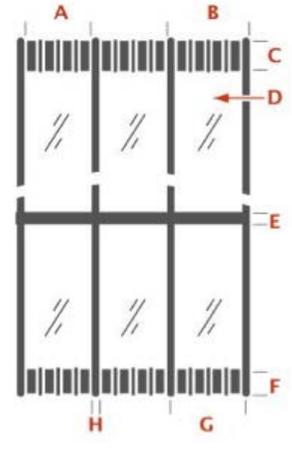

4 3/4" POLYCARBONATE (PRESTIGE)

A	Tempered glass 4 3/4 in. X 1/8 in.
B	Full panel width 7 in.
C	Top plate 5 1/4 in. 13 ga.
D	Top spacer tube size varies from curtain pattern to accommodate specific height.
E	Spacer plate with vinyl compression gasket 1 1/4 in. 13 ga.
F	Bottom plate 4 in. 13 ga.
G	On center 6 1/4 in.
H	Hinge 1 1/2 in.

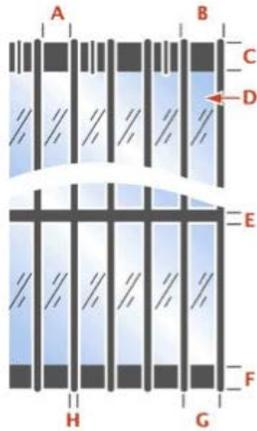

8 7/8" POLYCARBONATE (PRESTIGE WB)

A	Lexan or equivalent 8 7/8 in. X 1/8 in.
B	Full panel width 11 1/4 in.
C	Top plate 5 1/4 in. 11 ga.
D	Top spacer panel size varies from curtain pattern to accommodate specific height.
E	Spacer plate with vinyl compression gasket 1 1/4 in. 11 ga.
F	Bottom plate 4 in. 11 ga.
G	On center 10 1/2 in.
H	Hinge 1 1/2 in.

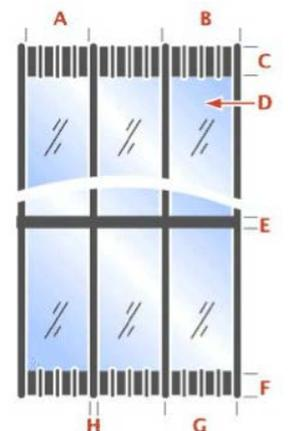

3" PERFORATED (SLIMLINE)

A	Space between hinges 3 in.
B	Full panel width 4 1/4 in.
C	Top plate 2 in. 13 ga. aluminum
D	Continuous interlocking hinge
E	One or more 2 in. 13 ga. aluminum dividers (based on height)
F	Perforated aluminum panel 14 ga. 3/16 in. holes on center (50% perforation)
G	Bottom plate 2 in. 13 ga. aluminum
H	On center 3 1/2 in.

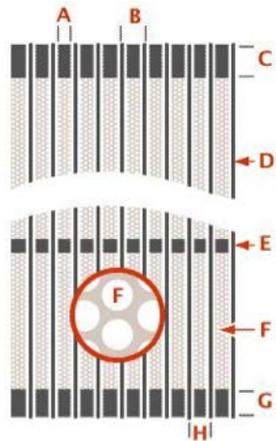

4 3/4" PERFORATED (PARAVENT)

A	Perforated steel 4 3/4 in. X 18 ga.
B	Full panel width 7 in.
C	Top plate 5 1/4 in. 13 ga.
D	Top spacer tube size varies from curtain pattern to accommodate specific height.
E	Spacer plate with vinyl compression gasket 1 1/4 in. 13 ga.
F	Bottom plate 4 in. 13 ga.
G	On center 6 1/4 in.
H	Hinge 1 1/2 in.
I	Perforation detail 3/16 in

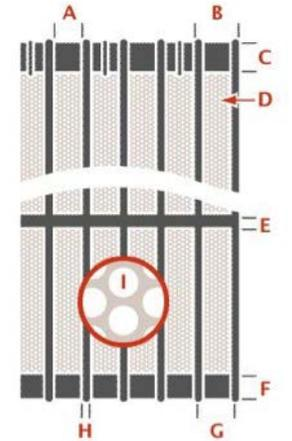

COMMERCIAL DOORS

Grille Styles

STANDARD CLOSURES

8 7/8" PERFORATED (PARAVENT WB)	
A	Perforated steel 8 7/8 in. X 18 ga.
B	Full panel width 11 1/4 in.
C	Top plate 5 1/4 in. 11 ga.
D	Top spacer panel size varies from curtain pattern to accommodate specific height.
E	Spacer plate with vinyl compression gasket 1 1/4 in. 11 ga.
F	Bottom plate 4 in. 11 ga.
G	On center 10 1/2 in.
H	Hinge 1 1/2 in.
I	Perforation detail 3/16 in.

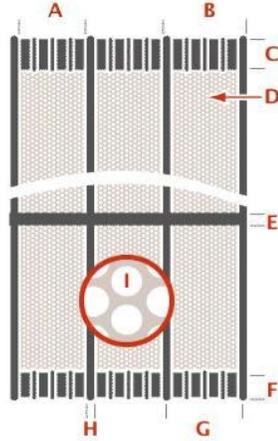

3" SOLID ALUMINUM (SLIMLINE)	
A	Space between hinges 3 in.
B	Full panel width 4 1/4 in.
C	Top plate 2 in. 13 ga. aluminum
D	Continuous interlocking hinge
E	Aluminum panel 13 ga.
F	Bottom plate 2 in. 13 ga. aluminum
G	On center 3 1/2 in.

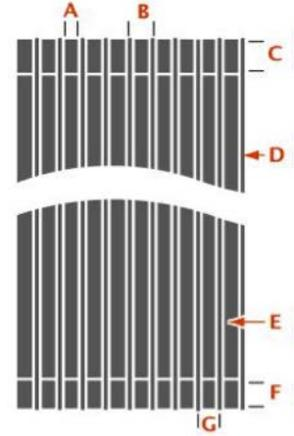

4 3/4" SOLID ALUMINUM (OPAQUE)	
A	Solid aluminum 4 3/4 in. X 13 ga.
B	Full panel width 7 in.
C	Top plate 5 1/4 in. 13 ga.
D	Hinge 1 1/2 in.
E	On center 6 1/4 in.

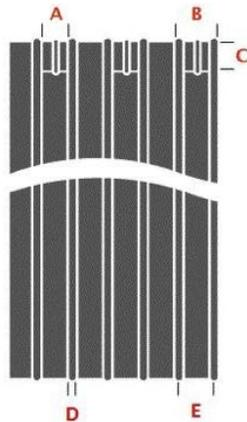

8 7/8" SOLID (OPAQUE WB)	
A	Solid aluminum 8 7/8 in. X 11 ga.
B	Full panel width 11 1/4 in.
C	Top plate 5 1/4 in. 11 ga.
D	On center 10 1/2 in.
E	Hinge 1 1/2 in.

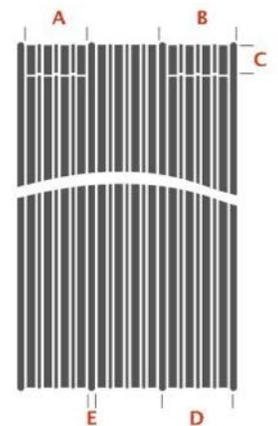

EZ Closures

3 1/8" POLYCARBONATE (EZ CLEAR)
Polycarbonate panels 4 inch side folding closure with 6 inch wide pocket

3 1/8" PERFORATED (EZ VENT)
Perforated aluminum 4 inch side folding closure with 6 inch wide pocket

3 1/8" ROD (EZ GRILLE)
Straight pattern rod and link 4 inch side folding closure with 6 inch wide pocket

3 1/8" SOLID (EZ GUARD)
Solid aluminum 4 inch side folding closure with 6 inch wide pocket

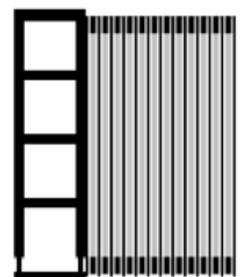
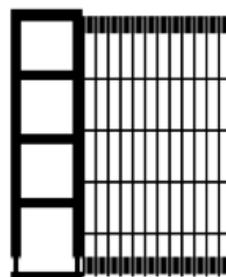
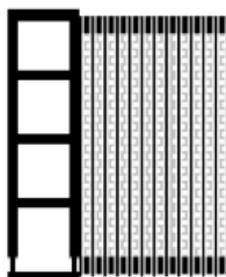
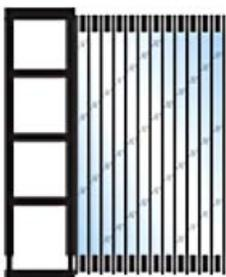

ACCORDION FOLDING GRILLES

Grille Clearance Elevations

Curtain height is adjustable to a maximum of 1" (25 mm) upward, and 1" (25 mm) downward to compensate for unexpected field conditions.

This will vary top clearance from curtain to track from 1/2" (13 mm) to 2 1/2" (63 mm).

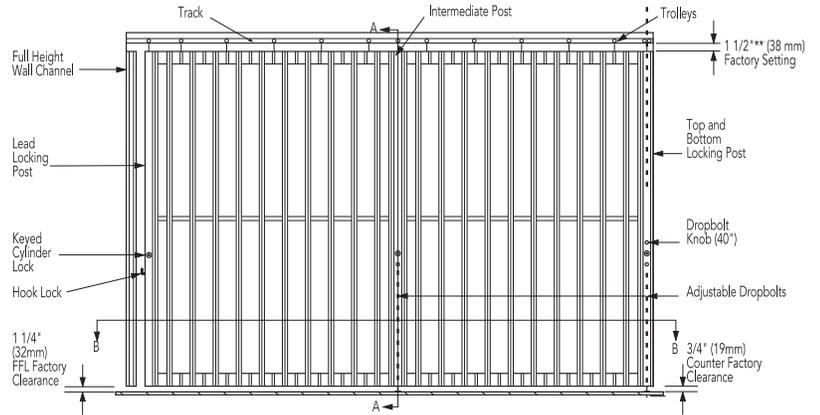

Side Folding Grilles Post Descriptions

- 1 Wall channel
- 2 Lead post – with cylinders interior/exterior engaging hook bolt lock
- 3 Bi-part – with cylinders interior/exterior and interior drop bolt
- 4 Bi-part – with cylinder exterior and interior thumb turn and drop bolt
- 5 Intermediate post – with interior cylinder lock and drop bolt
- 6 Intermediate post – with interior drop bolt
- 7 Top and bottom post – with interior/exterior cylinder lock and rubber bumper
- 8 Top and bottom post – with cylinder lock and protection plate
- 9 Traveling end post – with protection plate, post self locks into floor "v" stop
- 10 Fixed end post
- 11 90° Bi-part – with interior/exterior cylinders and exterior drop bolt

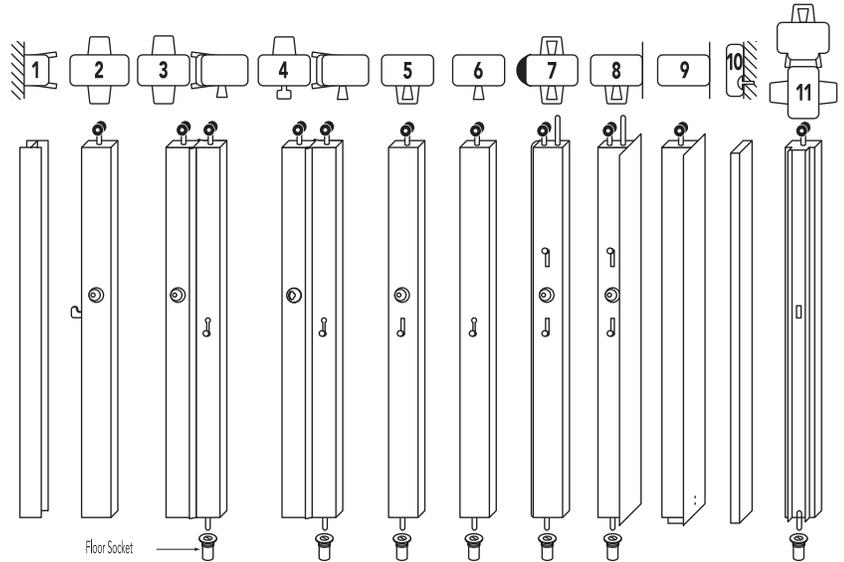

BI-PART, POCKET BOTH SIDES

Commonly used to break up large curtains or to provide a balanced look.

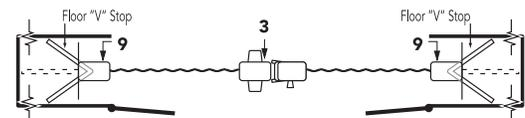

SINGLE STACK INTO POCKET WITH WALL CHANNEL OR POCKET GRILLE

In this configuration, the traveling end post becomes a secured, keyed locking post and avoids drilling for floor socket needed by #7 post.

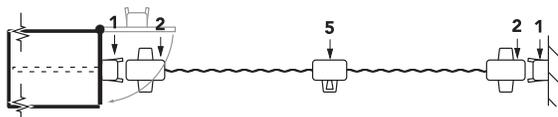

STACK BETWEEN JAMBS

For use where there is no pocket availability. Note: use of #7 posts for the lead or end are a viable alternative.

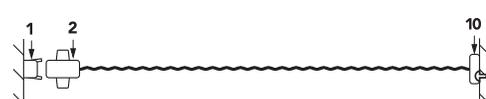

COMMERCIAL DOORS

Typical Layouts

SPECIAL RADIUS CURVE

Enables the curtain to follow any lease line and adds a dramatic look to the entrance.

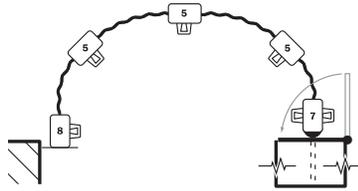

Note: On all layout drawings, top is exterior, bottom is interior of opening.

DUAL TRACK

For use when minimal pocket depth is available.

A top and bottom lead post with attached spacing post to an angled wall allows access to locking on the acute angle side.

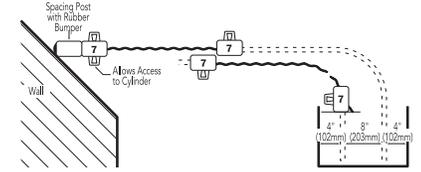

90° CURVE WITH BI-PART SINGLE STACK INTO POCKET

Enables the curtain to follow any lease line and adds a dramatic look to the entrance.

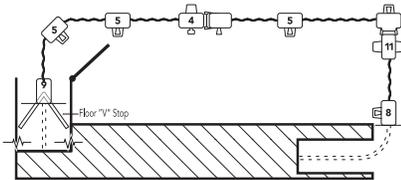

“S” CURVE (2 135° CURVES) WITH SINGLE STACK INTO 90° POCKET

S-curves enable the curtain to avoid obstruction and provide added visual interest.

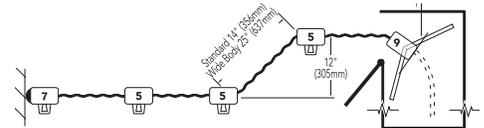

Track Details

DROP CEILING RECESSED TRACK

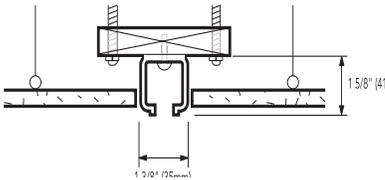

DROP CEILING SURFACE TRACK

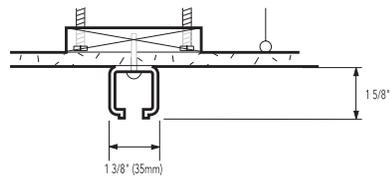

DRYWALL CEILING RECESSED TRACK

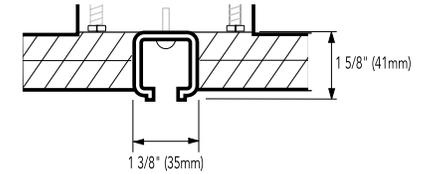

FACE-OF-WALL MOUNT

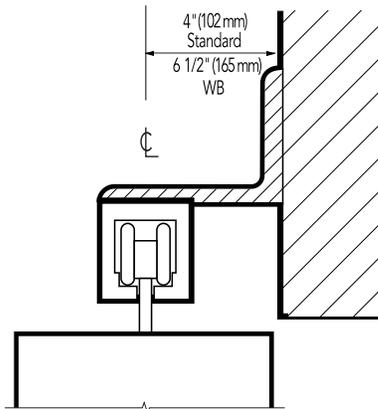

OPTIONAL CURTAIN HEIGHT ADJUSTMENT

Note: load requirements are 3 lbs. per square foot (1.66 Kg per square meter) and 200 lbs. per linear foot (91 kg per linear meter) stacked. Threaded rod 1/2" (13 mm) with 2" (51 mm) x 6" (152 mm) wood stud shown.

Other acceptable mounts include 2" (51 mm) x 4" (102 mm) steel or wood stud. A column is not required for support. Header and supporting structure by others.

*Curtain height is adjustable up to 1" (25 mm) up or down without removal. (Optional)

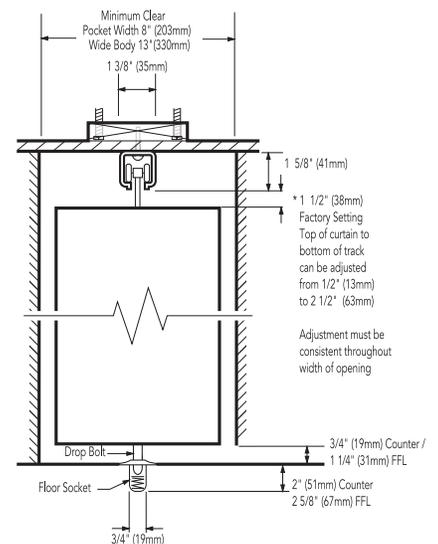

ACCORDION FOLDING GRILLES

Curves Details

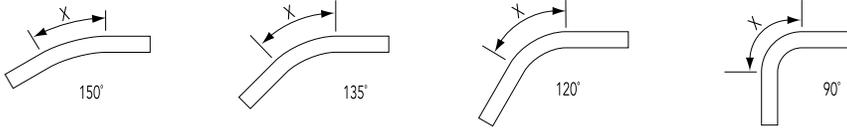

Note: special radius curves are available only with a template supplied. Curves cannot be smaller than 90° double 3/4" (19 mm) plywood eliminates problem blocking of curved layouts.

Wide body models must use standard 22" radius on 90° curves. Larger special curves are also acceptable.

DIMENSION X		
RADIUS	CURVE	X
10" (254 mm)	90°	16" (406 mm)
	120°	10 1/2" (406 mm)
	135°	7 15/16" (202 mm)
	150°	5 1/4" (133 mm)
14" (356 mm)	90°	22" (559 mm)
22" (559 mm)	90°	34 1/2" (876 mm)

Right Angle Pocket Specifications

STANDARD

13/16" (30 mm) per linear foot plus 3" (76 mm) for each posts. min. clear pocket width 8" (203 mm)

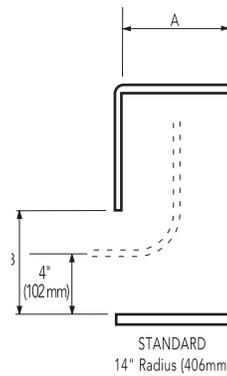

STANDARD DIMENSIONS A AND B	
"A" POCKET WIDTH	"B" POCKET DOOR WIDTH
8" (203 mm)	18" (457 mm)
9" (229 mm)	13 5/8" (346 mm)
10" (254 mm)	12" (305 mm)
11" (279 mm)	10 7/8" (276 mm)
12" (305 mm)	10" (254 mm)
13" (330 mm)	9 5/16" (237 mm)
14" (356 mm)	8 13/16" (224 mm)
15" (381 mm)	8 7/16" (214 mm)
16" (406 mm)	8 3/16" (208 mm)

WIDE BODY

3/4" (19 mm) per linear foot plus 3" (76 mm) for each posts. min. clear pocket width 13" (330 mm)

Add 3" (76 mm) per stack per locking post. Add 8" (203 mm) to stack per emergency egress grille. Add 6" (152 mm) each for bi-part.

Note: the maximum space between locking posts is 10' (3,048 mm) for full height grilles, 6' (1,829 mm) on standard counter height and at center of every curve.

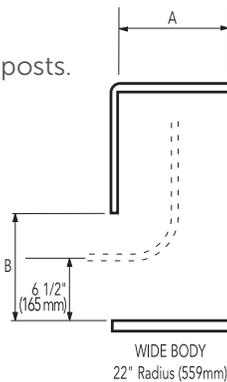

WIDE BODY DIMENSIONS A AND B	
"A" POCKET WIDTH	"B" POCKET DOOR WIDTH
13" (330 mm)	26" (660 mm)
14" (356 mm)	20" (508 mm)
16 1/2" (419 mm)	17" (432 mm)
20" (508 mm)	14" (356 mm)
26" (660 mm)	13" (330 mm)

Complementing its 24-hour emergency service, American Door maintains its own overhead door manufacturing plant and parts warehouse. This enables us to quickly and efficiently resolve all point-of-entrance security issues. In most cases our customers find that their emergencies receive a response within two hours and most repairs are complete the next business day. American Door can even ship hard to get door parts.

TYPES OF FOLDING GRILLES



ROYAL
(Tempered Glass)



IMPACT
(Polycarbonate)

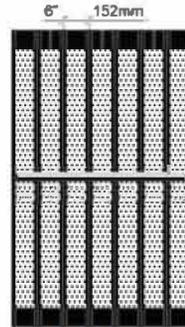

AEROFLEX
(Perforated Steel)

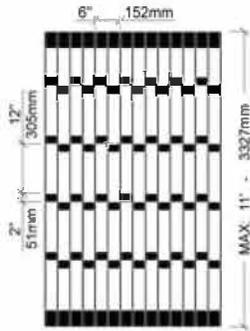

SYSTEM S-12
(Open Style)

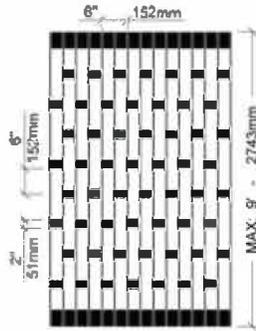

SYSTEM S-525
(Open Style)

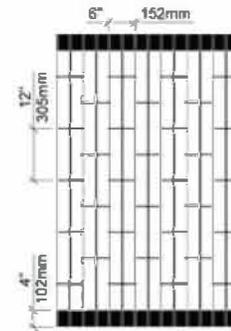

SYSTEM S-126
(Open Style)

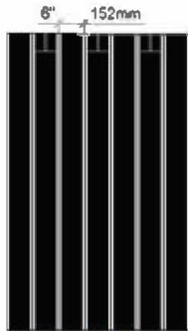

GLOBAL
(Opaque Solid)

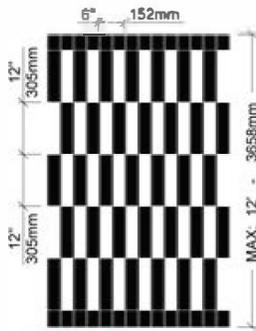

CONCEPT 1212
(Open Style)

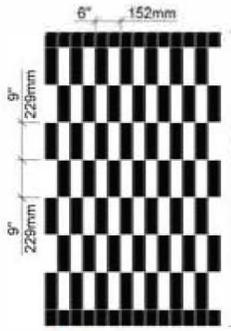

CONCEPT99
(Open Style)

ACCORDION FOLDING GRILLES

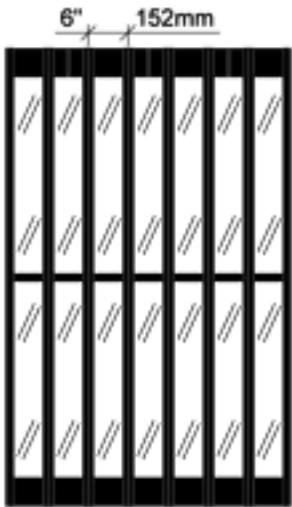

Visibly Elegant Protection
This high performance tempered glass model offers excellent visibility and exceptional protection. Perfect for banks and stores, or any other location requiring both maximum visibility and secure closing.

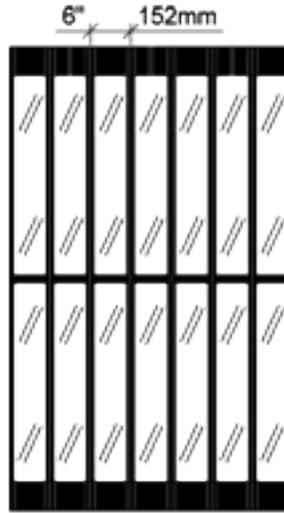

Highly Resistant, Surprisingly Light.
Polycarbonate panels provide remarkable impact-resistance in a surprisingly light package. The panels are 1.6 mm (1/16") thick.

